

ALADIN

Design Piero Lissoni



ALADIN DOUBLE SWING PLAIN



ALADIN

Design Piero Lissoni

ALADIN DOUBLE SWING PLAIN MONO

Aladin Double Swing Plain Mono è una porta doppia a battente raso muro prodotta su misura, con cerniere a perno regolabili. Un vetro è applicato su un lato di un telaio in alluminio, disponibile in cinque finiture, in modo da avere una faccia con superficie planare e l'altra con superficie arretrata rispetto alla cornice perimetrale. Il vetro può essere monolitico temperato 6 mm oppure stratificato 3 + 3 mm temperato, disponibile in una vastissima gamma di finiture. Tutti i vetri sono certificati secondo le normative di sicurezza ANSI Z97.1 e UNI EN12150.

Sono disponibili anche pannelli in gres con diverse finiture. E' possibile montare diversi tipi di serrature e scegliere tra maniglia o pomolo, nella stessa finitura del telaio. Il controtelaio in alluminio decappato, invisibile quando la porta è chiusa, è disponibile sia per pareti cementizie sia in cartongesso e può essere verniciato direttamente con la pitturazione delle pareti. L'anta singola è disponibile anche nella versione filo soffitto. L'intero gruppo maniglia è trattato con una speciale vernice igienizzante (testata secondo la norma ISO 22196:2011) che, contrastando la proliferazione batterica, garantisce la massima igiene e pulizia delle superfici.

Aladin Double Swing Plain Mono is double a custom-made swing door with concealed frame and adjustable pivot hinges.

A glass is applied on one side of an aluminium frame, available in five different finishes, so as to have a face with a flush surface, and another surface rebated from the perimeter aluminium frame. The glass can be monolithic tempered 6 mm in a single piece or tempered laminated 3 + 3 mm available in a wide range of different finishes. All glasses are certified according to the safety regulation ANSI Z97.1 and UNI EN12150. Panels in stoneware with different finishes are available too. It is possible to assemble different kind of locks and choose between handle and knob, which are provided in the same finishes as the frame. The pickled aluminium subframe, invisible when the door is closed, is available for both cement walls and plasterboard and can be varnished during the painting of the walls. The single swing door is also available fitted flush to the ceiling. The entire handle set is treated with a special sanitizing varnish (tested according to ISO 22196: 2011) which, by counteracting bacterial overgrowth, guarantees maximum hygiene and cleanliness of the surfaces.



codice
code

ASWPM2

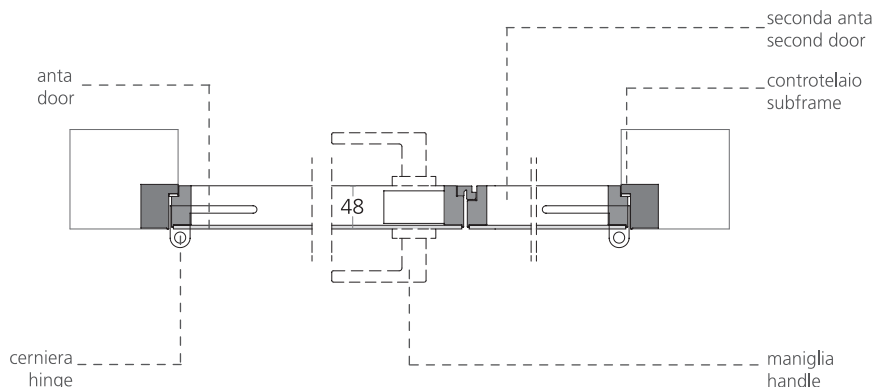

GLAS
ITALIA

Sede, direzione commerciale e showroom: Via Cavour 29 - 20846 Macherio (MB)
tel. +39 039.23 23 202 ra - fax +39 039.23 23 212 - e-mail: glas@glasitalia.com - www.glasitalia.com

ALADIN

Design Piero Lissoni

ALADIN DOUBLE SWING PLAIN DUO

Aladin Double Swing Plain Duo Aladin Swing Plain Duo è una porta a battente doppia raso muro prodotta su misura, con cerniere a perno regolabili.

Dei vetri temperati spessore 4 mm sono applicati su entrambe le facce di un telaio in alluminio, disponibile in cinque finiture, in modo da formare un volume con una camera d'aria interna.

I vetri, disponibili in un'ampia gamma di finiture, sono certificati secondo le normative di sicurezza ANSI Z97.1 e UNI EN 12150. Sono disponibili anche pannelli in gres o in legno, con diverse finiture ed essenze. E' possibile montare diversi tipi di serrature e scegliere tra maniglia o pomolo nella stessa finitura del telaio.

Il controtelaio in alluminio decappato, invisibile quando la porta è chiusa, è disponibile sia per pareti cementizie sia in cartongesso e può essere verniciato direttamente con la pitturazione delle pareti. L'intero gruppo maniglia è trattato con una speciale vernice igienizzante (testata secondo la norma ISO 22196:2011) che, contrastando la proliferazione batterica, garantisce la massima igiene e pulizia delle superfici.

Aladin Double Swing Plain Duo is a double custom-made swing door with a concealed frame and with adjustable pivot hinge openings.

The 4 mm thick tempered glasses are applied on both faces of an aluminium frame, available in five different finishes, so as to form a volume with an internal air chamber.

The glasses are available in a wide range of finishes and they are certified according to the safety regulation ANSI Z97.1 and UNI EN 12150.

Panels in stoneware and in wood with different finishes and essences are available too. It is possible to assemble different locks and choose either between handle and knob in the finishes as the frame. The pickled aluminium subframe, invisible when the door is closed, is available for both cement walls and plasterboard and can be varnished during the painting of the walls. The entire handle set is treated with a special sanitizing varnish (tested according to ISO 22196: 2011) which, by counteracting bacterial overgrowth, guarantees maximum hygiene and cleanliness of the surfaces.



codice
code

ASWPD2

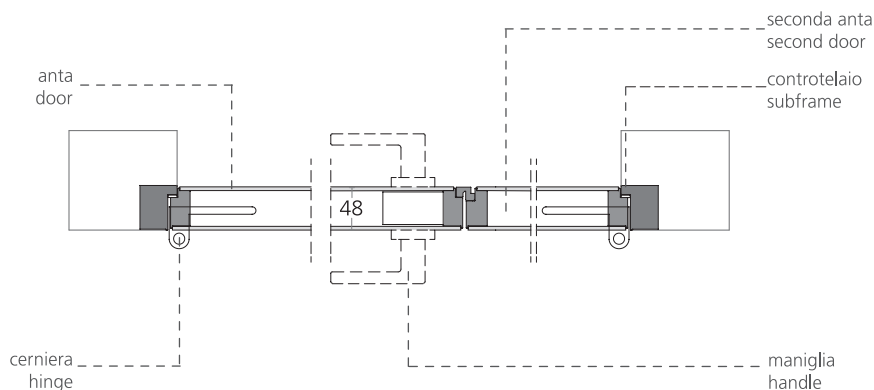

GLAS
ITALIA

Sede, direzione commerciale e showroom: Via Cavour 29 - 20846 Macherio (MB)
tel. +39 039.23 23 202 ra - fax +39 039.23 23 212 - e-mail: glas@glasitalia.com - www.glasitalia.com

ALADIN

Design Piero Lissoni

ALADIN DOUBLE SWING PLAIN MONO

ALADIN DOUBLE SWING PLAIN DUO

MANIGLIE PORTA DOPPIO BATTENTE / HANDLES DOUBLE SWING DOOR

Maniglia senza blocco /
Handle without block

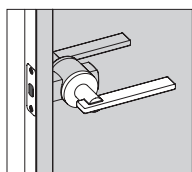

codice
code
LSBA

Maniglia con chiusura privacy /
Handle with privacy lock

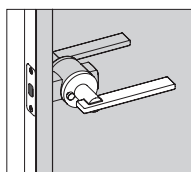

codice
code
LCPA

Maniglia con chiave /
Handle with key lock

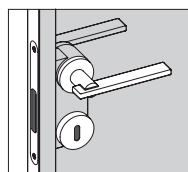

codice
code
LCCA

Maniglia con cilindro /
Handle with cylinder lock

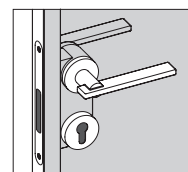

codice
code
LCYA

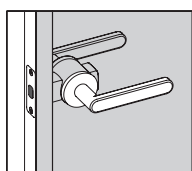

codice
code
LSBB

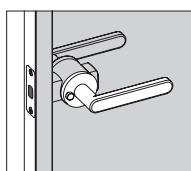

codice
code
LCPB

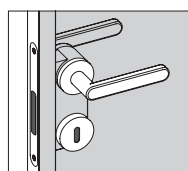

codice
code
LCCB

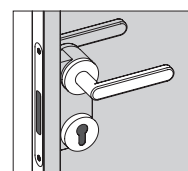

codice
code
LCYB

POMOLI PORTA DOPPIO BATTENTE / KNOBS DOUBLE SWING DOOR

Pomolo senza blocco /
Knob without block

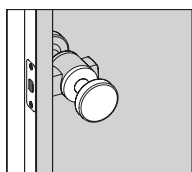

codice
code
PSB

Pomolo con chiusura privacy /
Knob with privacy lock

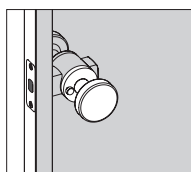

codice
code
PCP

Pomolo con chiave /
Knob with key lock

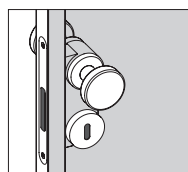

codice
code
PCC

Pomolo con cilindro /
Knob with cylinder lock

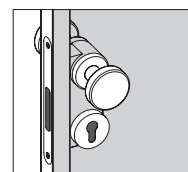

codice
code
PCY