

ALADIN

Design Piero Lissoni



ALADIN POCKET FRAME



ALADIN

Design Piero Lissoni

ALADIN POCKET FRAME MONO

Le ante **Aladin Pocket Frame Mono**, prodotte su misura e perfettamente integrabili nei più diffusi sistemi di porte scorrevoli a scomparsa con stipite, hanno un vetro applicato su un lato del telaio, in modo da avere una faccia con superficie planare e l'altra con superficie arretrata rispetto alla cornice perimetrale d'alluminio disponibile in cinque diverse finiture.

Il vetro, disponibile in una vastissima gamma di finiture, può essere monolitico temperato 6 mm oppure stratificato 3 + 3 mm.

Tutti i vetri sono certificati secondo le normative di sicurezza ANSI Z97.1 e UNI EN12150.

Sono disponibili anche pannelli in gres con diverse finiture. La porta viene fornita completa di stipite telescopico in alluminio per pareti con spessore da 90 a 130 mm nella stessa finitura del telaio dell'anta.

Per dimensioni maggiori devono essere considerati gli extra prezzi indicati.

Le due versioni, ad anta singola e ad anta doppia, possono essere fornite con o senza serratura. A richiesta vengono forniti anche i controtelai per cartongesso e intonaco.

The **Aladin Pocket Frame Mono** doors are custom-made, can be integrated into the most common systems of sliding pocket doors with jamb and have a glass applied on one side of the frame so that one side has a flush surface whilst the other is rebated from the aluminium frame available in five different finishes. The glass, available in a wide range of finishes, can be monolithic tempered 6 mm as a single piece or laminated 3 + 3 mm.

All glasses are certified according to the safety regulation ANSI Z97.1 and UNI EN12150.

Panels in stoneware with different finishes are available too.

The door is supplied with telescopic aluminium jambs, for walls with thickness from 90 up to 130 mm, in the same finish as the door frame.

For larger dimensions, additional costs as specified must be taken into consideration.

The two versions, with single or double door, can be provided with or without lock. Subframes for plasterboard or brick walls can be provided on demand.

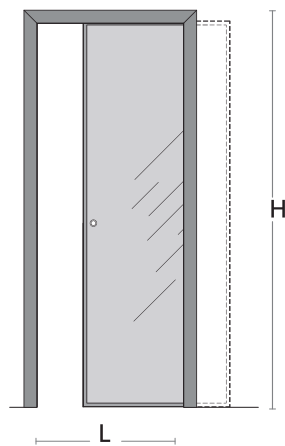

codice
code
APOF1M

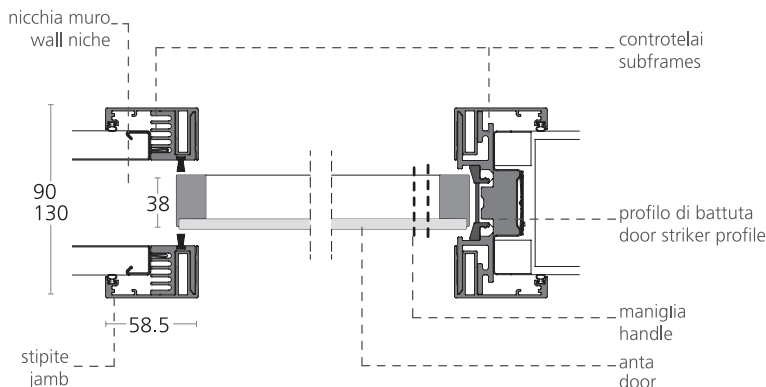

GLAS
ITALIA

Sede, direzione commerciale e showroom: Via Cavour 29 - 20846 Macherio (MB)
tel. +39 039.23 23 202 ra - fax +39 039.23 23 212 - e-mail: glas@glasitalia.com - www.glasitalia.com

ALADIN POCKET FRAME MONO

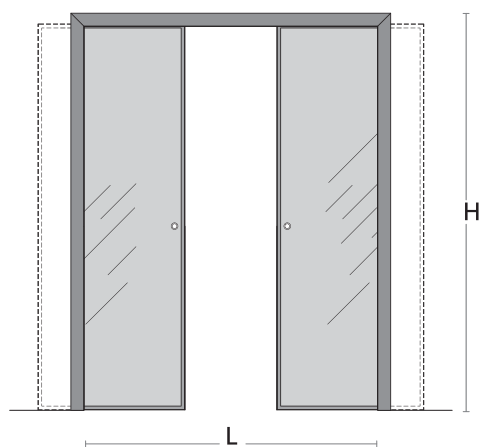

codice
code
APOF2M

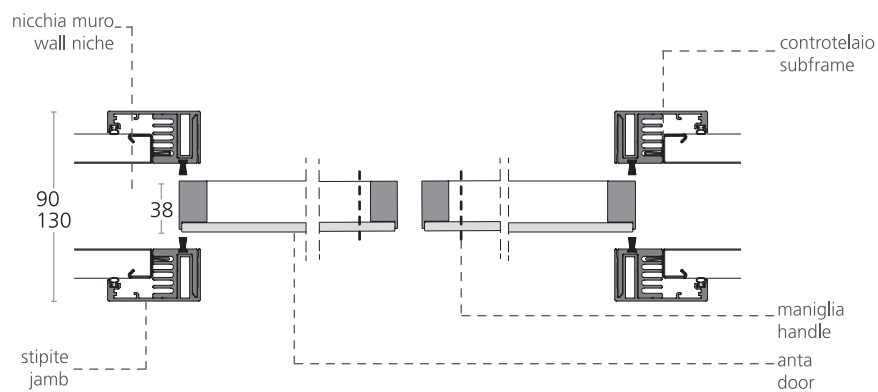

ALADIN

Design Piero Lissoni

ALADIN POCKET FRAME DUO

Le ante **Aladin Pocket Frame Duo**, prodotte su misura e perfettamente integrabili nei più diffusi sistemi di porte scorrevoli a scomparsa con stipite, hanno vetri temperati spessore 4 mm applicati su entrambe le facce del telaio d'alluminio, disponibile in cinque diverse finiture, in modo da formare un volume con una camera d'aria interna.

La porta viene fornita completa di stipite telescopico in alluminio per pareti con spessore da 90 a 130 mm nella stessa finitura del telaio dell'anta.

Per dimensioni maggiori devono essere considerati gli extra prezzi indicati.

I vetri, disponibili in un'ampia gamma di finiture, sono certificati secondo le normative di sicurezza ANSI Z97.1 e UNI EN12150.

Sono disponibili anche pannelli in gres o in legno, con diverse finiture ed essenze.

Le due versioni, ad anta singola e ad anta doppia, possono essere fornite con o senza serratura.

A richiesta vengono forniti anche i controtelai per cartongesso e intonaco.

The **Aladin Pocket Frame Duo** doors are custom-made, can be integrated into the most common pocket systems of sliding pocket doors with jamb and have 4 mm thick tempered glass applied on both faces of the aluminium frame, available in five different finishes, so as to form a volume with an internal air chamber.

The door is supplied with telescopic aluminium jambs, for walls with thickness from 90 up to 130 mm, in the same finish as the door frame.

For larger dimensions, additional costs as specified must be taken into consideration.

The glasses are available in a wide range of finishes and they are certified according to the safety regulation ANSI Z97.1 and UNI EN12150.

Panels in stoneware and in wood with different finishes and essences are available too.

The two versions, with single or double door, can be provided with or without lock.

Subframes for plasterboard or brick walls can be provided on demand.

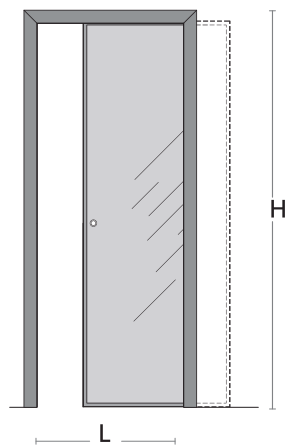

codice
code

APOF1D

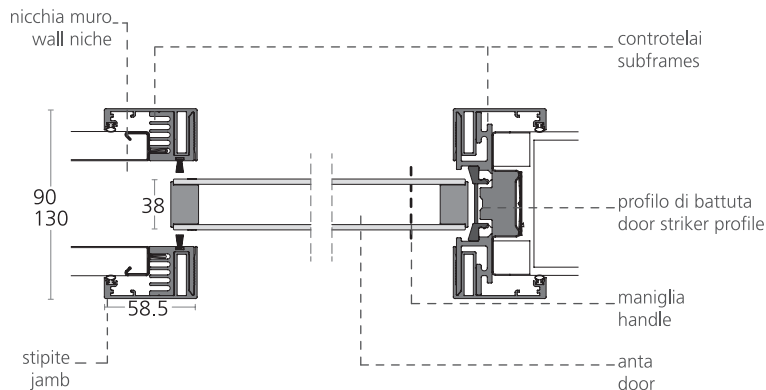

GLAS
ITALIA

Sede, direzione commerciale e showroom: Via Cavour 29 - 20846 Macherio (MB)
tel. +39 039.23 23 202 ra - fax +39 039.23 23 212 - e-mail: glas@glasitalia.com - www.glasitalia.com

ALADIN POCKET FRAME DUO

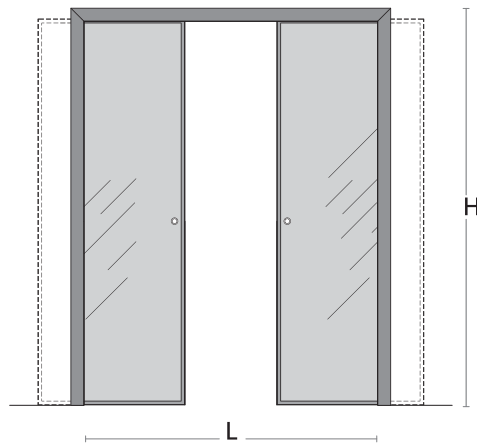

codice
code
APOF2D

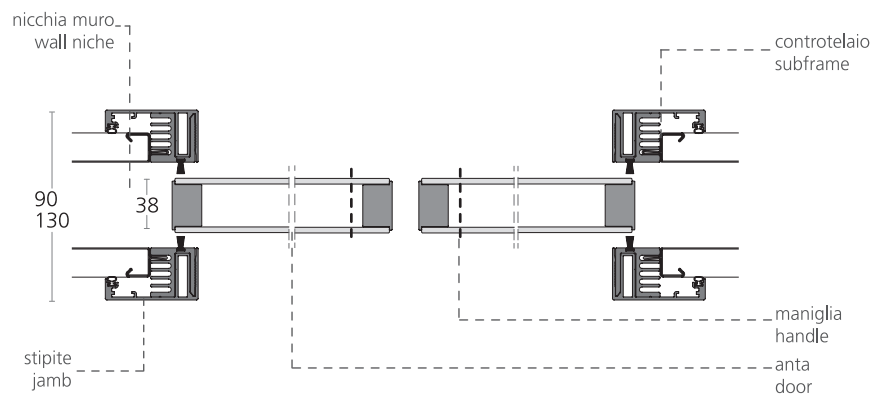

ALADIN

Design Piero Lissoni

ALADIN POCKET FRAME MONO

ALADIN POCKET FRAME DUO

MANIGLIE PORTA SCOMPARSA / HANDLES POCKET DOOR

Maniglia senza supporto /
Handle without support

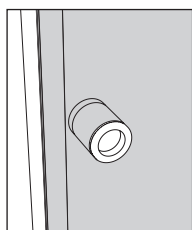

codice
code
MSSP

Maniglia ovale senza supporto /
Oval handle without support

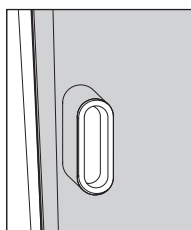

codice
code
MSOP

Maniglia con supporto /
Handle with support

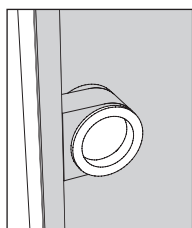

codice
code
MCSP

Maniglia con chiave /
Handle with key lock

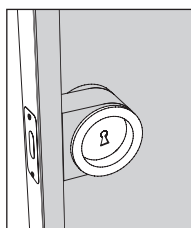

codice
code
MCCP

Maniglia con nottolino /
Handle with revolving plug

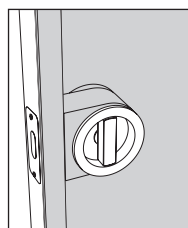

codice
code
MCNP

ALADIN

Design Piero Lissoni

ALADIN POCKET FRAME MONO

ALADIN POCKET FRAME DUO

MANIGLIE PORTA DOPPIA SCOMPARSA / HANDLES DOUBLE POCKET DOOR

Maniglia senza supporto /
Handle without support

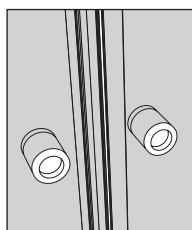

codice
code
M2SSP

Maniglia ovale senza supporto /
Oval handle without support

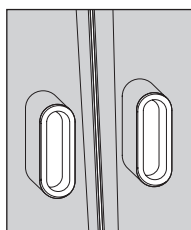

codice
code
M2SOP

Maniglia con supporto /
Handle with support

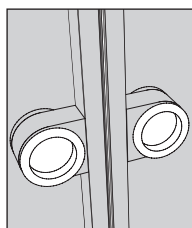

codice
code
M2CSP

Maniglia con chiave /
Handle with key lock

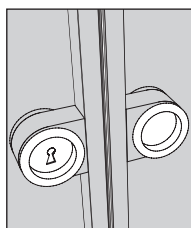

codice
code
M2CCP

Maniglia con nottolino /
Handle with revolving plug

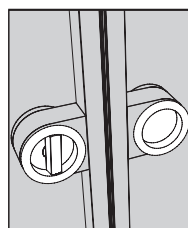

codice
code
M2CNP